

USER'S MANUAL

HAKI UNIVERSAL

International version



Important information

HAKI's product liability and user's manuals apply only to scaffolds that are entirely composed of components that have been made and supplied by HAKI.

HAKI's type examination certificate applies only to scaffolds whose materials, dimensions and design accord with those specified in the documentation upon which this certificate is based.

HAKI's scaffold systems must not be erected using components of makes other than HAKI or be connected to scaffolds of makes other than HAKI. In such cases, a special study of load-bearing capacity must be carried out. However, HAKI has no objection to the customary addition of scaffold tubes and approved couplers to the scaffold.

Adding components from different suppliers may invalidate the insurance cover.

HAKI reserves the right to make technical modifications on a continual basis.

This user's manual is to be used in conjunction with HAKI training courses.















A user's manual should be provided to the user together with the scaffolding.

The latest versions of HAKI user's manuals can be downloaded from our website, www.HAKI.com.

For scaffold structures that are not covered by this user's manual, please contact HAKI's technical department.

HAKI colour code

Horizontals and diagonals are marked with their nominal sizes (bay sizes) and a colour code. The marking is a useful means of identification when erecting and handling the scaffold material.

564 	1050 	1964 	3050 
700 	1250 	2050 	*3650 
770 	1550 	2500 	*4050 
1010 	1655 	2550 	* non-stock length

Forces and dimensions

1000 N = 1 kN ~ 100 kg

10 N ~ 1 kg

All measurements in mm

© Copyright HAKI AB, 2019

The reproduction of text and pictures/illustrations without HAKI's permission is prohibited.

HAKI Universal

The modular scaffold has been type examined by RISE Research Institutes of Sweden in accordance with SS-EN 12810-1 – Certificate No. 14 55 01.

General

The scaffolding has a bay width of 700, 770, 1010, 1250 or 1655 mm and a bay length of 3050 mm with a lift height of 2000 mm.

Single ledger beams(ERB) and ledger beams(LBL) can be used both as ledgers and transoms. HAKI decking units are suitable for use as decking.

Components for the HAKI Universal system are hot-dip galvanized.

Older components that are covered by the certificate







Ledger beam LB and Guardrail frame SKRD.

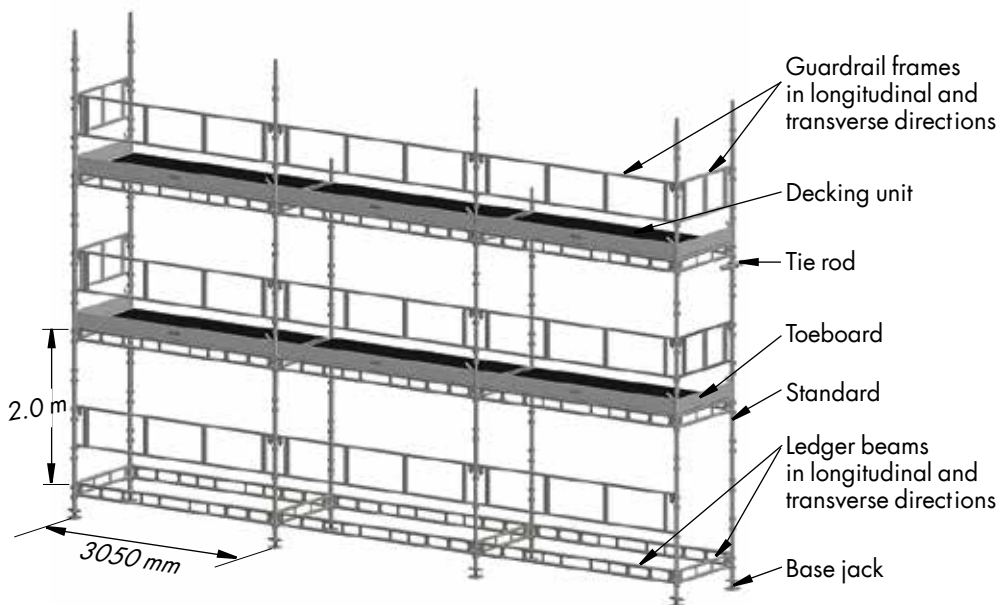
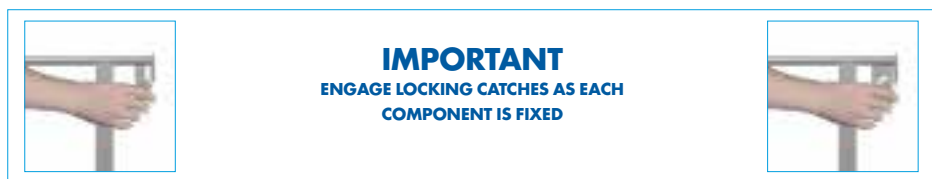



Marking





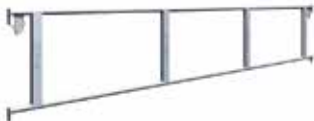
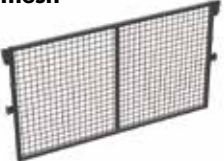

All components, with the exception of locking catches , locking pins etc, come permanently marked with the HAKI logo and the last two figures of the year of manufacture (1919).



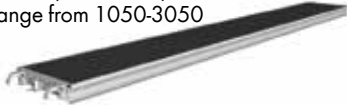

All loadbearing components are marked for full traceability. For further information, please refer to the HAKI Safety Guide.







Name	Code	Item No.	Weight
Base jack Adjustable BS = 55-570 mm	BS	2071000	5.0
			
Standard S Standard joint with spigot Ø38 Pockets at the same level Ø 48 mm	S 500 S 1000 S 1500 S 2000 S 3000	7016050 7016100 7016150 7016200 7016300	2.9 5.3 7.7 10.1 15.2
			
Open end Standard SC Standard joint without spigot Pockets at the same level Ø 48 mm	SC 353 SC 853 SC 1353 SC 1853	7011004 7011104 7011154 7011204	2.0 4.8 7.3 9.8
			
Intermediate Standard N=21	2000	7015007	12.5
			
Pin & Chain 16 mm Steel Ø 16 mm For reinforcing standard joint in connection with tensile load, e.g. when scaffolding is suspended, when lifting or when scaffolding is used for temporary roof.		5141257	0.3
			
Ledger beam LBL With spring locking catch Ø 34 mm	LBL 1250 LBL 1655 LBL 1964 LBL 2500 LBL 3050	7021122 7021162 7021192 7021252 7021302	6.5 6.7 8.0 10.9 12.3
			





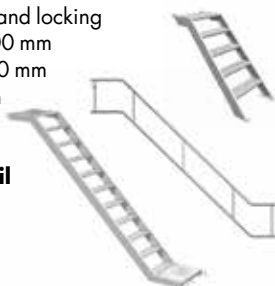
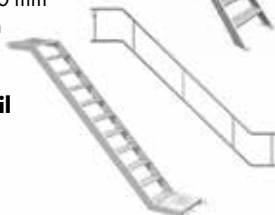
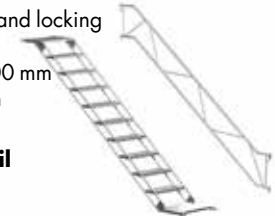

Name	Code	Item No.	Weight
Single tube beam ERB With spring locking catch Ø 48 mm 	ERB 564	7022050	2.7
	ERB 700	7022066	3.3
	ERB 770	7022073	3.6
	ERB 1010	7022097	4.3
	ERB 1250	7022121	5.1
	ERB 1655	7022161	6.3
	ERB 1964	7022191	7.3
	ERB 2500	7022246	9.7
	ERB 3050	7022301	11.3
Adjustable ledger 	310-470	7022026	2.4
Spacer 	300	7022030	1.5
	350	7022035	1.7
Guardrail frame GFL With spring locking catch Octagon 28 mm Sizes range from 700-4050 	GFL 564	7052056	3.1
	GFL 700	7052070	3.8
	GFL 770	7052077	4.0
	GFL 1010	7052104	4.8
	GFL 1250	7052124	5.7
	GFL 1655	7052164	7.4
	GFL 1964	7052194	8.1
	GFL 2500	7052254	9.2
	GFL 3050	7052304	10.5
Safety Gate with mesh Adjustable in height 	SGF 1250	7055121	14.6
	SGF 1655	7055161	17.0
	SGF 1964	7055191	19.4
	SGF 2500	7055250	23.2
	SGF 3050	7055300	26.8
Diagonal brace With wedge couplers Ø 48 mm DS 700/770 L=1707 DS 1250 L=2004 DS 1655 L=2285 DS 1964 L=2523 DS 2500 L=2967 DS 3050 L=3450 Sizes range from 700-4050 	DS 700/770	7122074	8.1
	DS 1250	7122124	9.1
	DS 1655	7122164	10.1
	DS 1964	7122194	10.7
	DS 2500	7121254	12.3
	DS 3050	7121304	14.2









Name	Code	Item No.	Weight
Decking Unit W=400 mm Load class 3 (2.0 kN/m ²) Sizes range from 1050-3050 	1250x400 AL	4073122	8.5
	1655x400 AL	4073162	10.5
	1964x400 AL	4073192	12.0
	2500x400 AL	4073252	16.1
	3050x400 AL	4073302	18.5
Decking Unit W=600 mm Load class 3 (2.0 kN/m ²) Sizes range from 700-3050 	1250x600 AL	4071122	10.6
	1655x600 AL	4071162	13.5
	1964x600 AL	4071192	15.8
	2500x600 AL	4071252	19.6
	3050x600 AL	4071302	24.6
Decking Unit Hatch Load class 3 (2.0 kN/m ²) Sizes range from 1655-3050 	3050x600 AL	4071305	24.5
Toeboard AL 	564	4161051	1.0
	700	4161071	1.3
	770	4161077	1.4
	1010	4161101	1.8
	1250	4161121	2.2
	1655	4161161	2.9
	1964	4161191	3.5
	2500	4161251	4.5
	3050	4161301	5.5
Ladder ST 	ST 2100 AL	2091210	3.4
HAKI Steel Plank W=230 mm Sizes range from 564-3050 Handles on 1964-3050 	564x230x90	21520564	4.2
	770x230x90	21520770	5.2
	1010x230x90	21521010	6.4
	1250x230x90	21521250	7.7
	1655x230x90	21521655	9.9
	1964x230x90	21521964	11.9
	2500x230x90	21522500	14.8
	3050x230x90	21523050	18.4

Name	Code	Item No.	Weight
AL plank W=230 mm L=770-2500 - load class 6 (6.0 kN/m ²) L=3050 - load class 5 (4.5 kN/m ²) Sizes range from 564-3050	ALP 770x230x90	2158077	4.1
	ALP 1250x230x90	2158120	5.6
	ALP 1655x230x90	2158160	6.9
	ALP 1964x230x90	2158190	7.8
	ALP 2500x230x90	2158250	9.5
	ALP 3050x230x90	2158300	11.2
 Steel Insert Panel L=564-2500 - load class 6 (6.0 kN/m ²) L=3050 - load class 5 (4.5 kN/m ²) Sizes range from 564-3050	770x230x90	2170770	4.1
	1010x230x90	2171010	5.1
	1250x230x90	2171250	6.0
	1655x230x90	2171655	7.6
	1964x230x90	2171964	8.7
	2500x230x90	2172500	10.8
3050x230x90	2173050	12.9	
 Bracket Without spigot With spring locking catch Ø 48 mm	SK 230	7211025	1.6
	SK 400	7211041	2.1
	SK 460	7211045	2.3
	SK 600	7211061	2.7
 Bracket adjustable Adjustable 460-690 mm	SK 460-690	7211069	4.1
	 Bracket With spigot With spring locking catch Ø 48 mm	SK 564	7211051
SK 700		7211067	6.1
SK 770		7211071	6.5
 Cantilever bracket To be combined with ERB 1250 or LBL 1250	SKD 1250	7212001	11.1
			

Name	Code	Item No.	Weight
Fan bracket		7214066	9.5
			
Stage Brackets	1 board	7208032	3.5
			
Corner bracket	SKH 460	7211046	9.5
Jaw width 22 mm Can be combined with the SK 460 bracket			
3 board corner bracket		7211053	18.0
Jaw width 22 mm Combined with the SKH 460 corner bracket			
Inside Board make-up Panel		2170800	6.8
			
Canopy Support Section		7014003	7.0
			

Name		Code	Item No.	Weight
Stair UTV AL With platform and locking LxH 3050x2000 mm alt. 2500x2000 mm Width 600 mm		UTV 500 AL	4102050	5.5
		UTV 1000 AL	4102100	9.0
		UTV 1500 AL	4102150	11.3
		UTV 2500x2000 AL	4102247	22.9
		UTV 3050x2000 AL	4102302	29.2
Stair handrail		HL 2500x2000 AL	4058245	9.2
		HL 3050x2000 AL	4058300	10.3
Stair UTV With platform and locking at the top LxH 3050x2000 mm Width 600 mm		UTV 3050x2000	2092200	39.7
		Stair handrail	HL 3050x2000	2161300
Handrail inner UTV For stair UTV AL and UTV G		HLI UTV AL	7058253	11.4
		HLI UTV	7058256	10.4
Entrance step		ITR 700-770	7103065	7.8
Guardrail post		SSKS 22 mm	7015006	6.1
Guardrail post Box type		SRS 1000	7015000	6.1

Name	Code	Item No.	Weight
Intermediate transom 	ITL 564	7204050	3.3
	ITL 700	7204070	3.6
	ITL 770	7204071	4.5
	ITL 1010	7204101	5.5
	ITL 1250	7204122	6.3
	ITL 1655	7204162	7.8
Lattice beam 500/6100 	500/6100	7031602	59.1
Puncheon unit 50 For tube diameter 50 mm Can be locked with spring pin 12 mm 	50	7208025	2.7
Puncheon unit For ledger beams With locking screw 	Puncheon unit same	7208018	3.9
Beam rider 50 For tube diameter 50 mm Can be locked with spring pin 12 mm 	BR 50	7208024	1.2
Beam rider For ledger beams With locking screw 	BRS	7208020	2.0
Double beam rider For guardrail frame or ledger beams With locking screw N=21 		7208033	2.4

Name	Code	Item No.	Weight
Cover plate AL AL checker plate With handle and hole for lashing For covering of holes when laying planks	995x495x4 940x600x4 1180x600x4	4011000 7900113 7900114	5.2 6.5 7.5
			
Castor wheel Wheel diameter 250 mm Adjustable 330-630 mm Safe working load 10.0 kN, moving 7.5 kN	LRG	2012001	10.6
			
Board to Ledger Bracket	230	7218023	3.95
			
Board to Board Bearer	230 460	7218032 7218033	3.0 3.5
			
Universal safety rail		7053111	7.5
			
Dead leg	Dead leg toeboard	7161715	2.3
			
Combination fitting		7205010	2.2
			
Advance guardrail tool		4052001	1.4
			

For other accessories, see HAKI Component List.

Information on safety when erecting and dismantling

1. Before erecting or dismantling a scaffold, try to fence off the working area if possible.
2. The location for the scaffold must be checked in order to prevent risks when erecting, dismantling and moving the scaffold and to ensure that work can be carried out safely with regard to level and slope, obstacles and wind conditions.
3. Make sure that all lifting equipment to be used, e.g. chain hoists, lifting ropes, pulley blocks, etc., has been thoroughly tested and approved by an authorized person in accordance with local regulations.
4. Check that tools and protective equipment are available at the worksite.
5. Wear appropriate personal safety equipment at all times, e.g. safety harnesses, proper independent lifelines with suitable fixings, etc.
6. When erecting and dismantling a scaffold, robust temporary decking must be used as temporary platforms for the scaffolders.
7. Always make sure that the safety locking devices that prevent a platform lifting off have been activated once a platform has been installed.
8. Study all relevant instructions or safety directions from the manufacturers of the various scaffolds that are to be used.
9. Never climb up a scaffold from the outside. Always use the stairs, ladders or climbing frames that are designed to provide access to the upper decks from the inside of the scaffold.
10. If the scaffold is to be used outdoors, erection or dismantling work must be discontinued if the weather conditions are too bad. Make sure that all loose components are properly fixed before leaving the scaffold.
11. Scaffolding work must be done by “competent workmen” under the supervision of a “competent person”.
12. Raising and lowering of parts, material and tools using ropes or slings must be carried out in a protected lifting area.
13. Lifting equipment must not be fitted to scaffolding unless ties or equivalent devices are secure.
14. Beware of any overhead power lines nearby.
15. Always observe and comply with the regulations issued by the local authorities concerned.

Instructions for dismantling

1. Dismantle the scaffold from the topmost lift.
2. Start by taking down the toe boards, mid-rails and hand rails.
3. Take down the topmost decking, then the stairs.
4. Take down the horizontals and diagonals of the topmost lift.
5. Finally, take down the standards of the topmost lift.
6. Repeat steps 3 to 5 to take down the second topmost lift and continue the whole process until the tower is completely dismantled.
7. Do not throw or dump the material onto the ground. This may damage the material or cause personal injury. The material must be lowered down to the ground by means of ropes or slings or carried down by hand.
8. Ties must not be removed before the dismantling process has reached the level in question.

Before erecting the scaffold, check and flatten out the ground. The ground must not be subject to uneven settlement. The ground's bearing capacity may be improved with the help of sole pads.

Start the erection of the scaffold at the highest ground point or as directed by the scaffold lay-out plan.



1. Lay out material to form base lift. Position base Jacks on sole pads, in approximate position of standards.

The external standards must be one metre higher than the next lift in order to be able to install guardrail frames prior to decking.

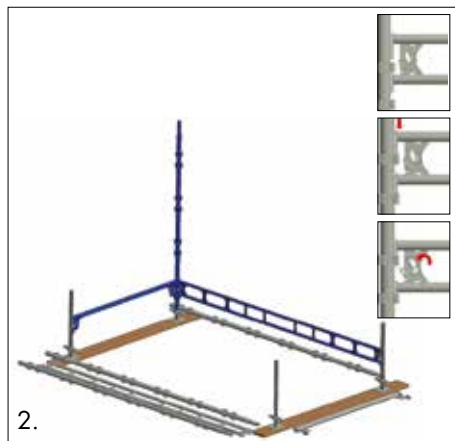

2. Install the first standard and fit a transom and ledger beam to it. The beams are fitted to the lowest group of pockets on the standard. Lock the beams into position.

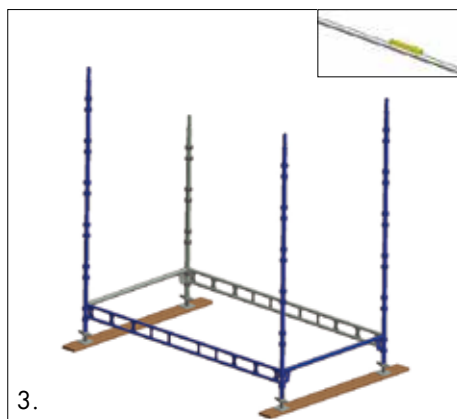

3. Install standards, transoms and beams in order to complete the first lift. Check the levels in both the transverse and longitudinal directions using a spirit level and adjust using the base jacks.

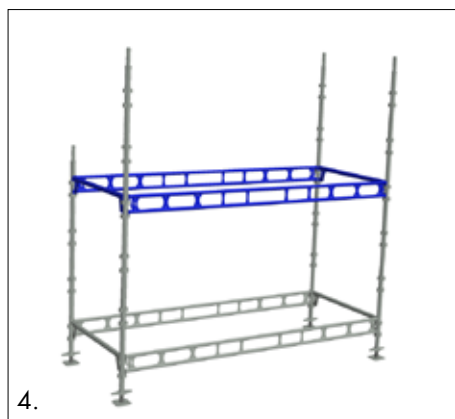

4. Install the transoms and beams for the second lift at the required lift height.

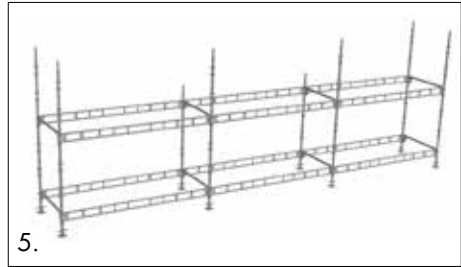
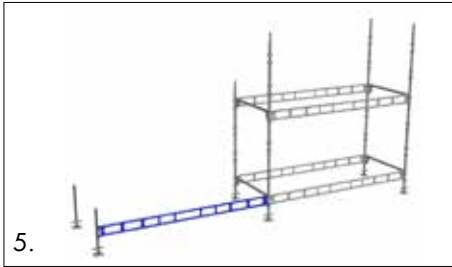

5. Additional bays can be erected, levelling and aligning each bay as you go.

Collective Fall Protection:

Installation of guardrail frames with the aid of advanced guardrail tool (AGR).



The Work at Height Regulations requires that a hierarchy for work at height be followed where collective fall prevention and protection measures should take priority over personal measures, for example the use of temporary working platforms with guard-rails would take priority over personal fall protection.



6a. Locate the advance guardrail tool onto frame close to vertical stiffener.

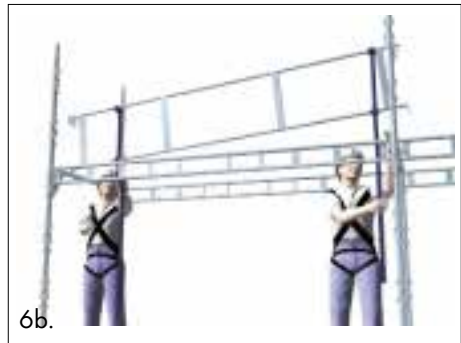

6b. Raise the guardrail frame.

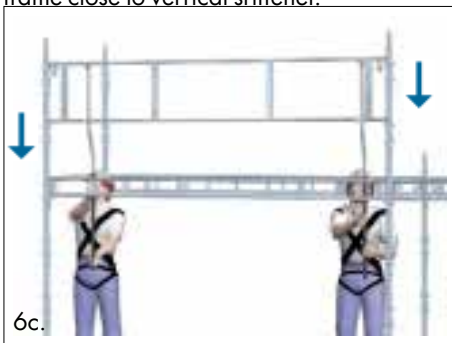

6c. Locate tongues into pockets of standards. Pull frame downward into position. Remove tool and secure locking catch.



6d. For subsequent lifts, install guardrail frames with the aid of the advanced guard-rail tool always behind longitudinal and transversal frames.

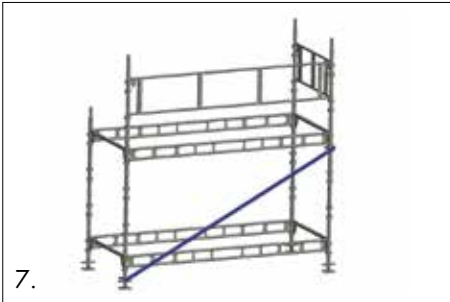

7.

7. Fit facade bracing as requested by the design drawing or as described on page 32 in this manual.

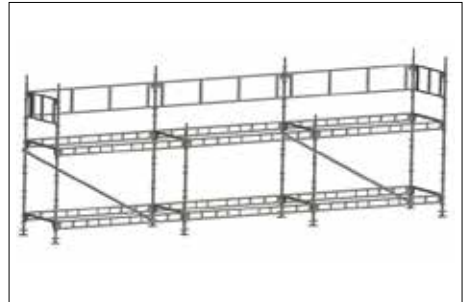

The scaffold is now ready for decking.

Decking

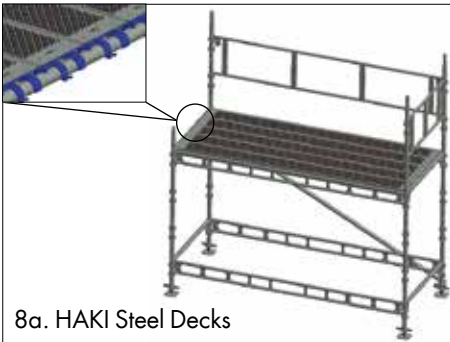

8a. HAKI Steel Decks

8a. Install HAKI steel decks over the transoms. Prevent uplift by closing locking catch.

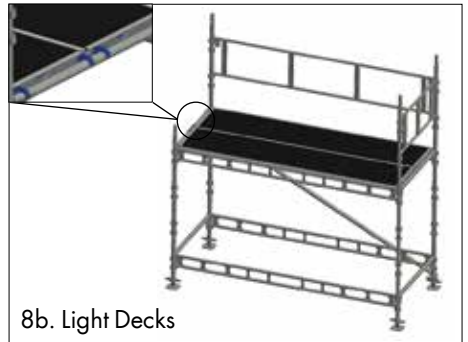

8b. Light Decks

8b. Install the light decking units over the transoms. Prevent uplift by closing locking catch.

Scaffold Boards



8c. Scaffold boards

8c. Install intermediate transoms on the top chord of ledger beams to support scaffold boards. Maximum spacing between intermediate transoms is 1200mm.

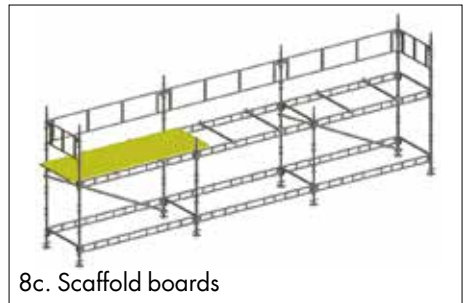

8c. Scaffold boards

NOTE: Maximum distance for end scaffold board: 150mm
Minimum distance for end scaffold board: 50mm.

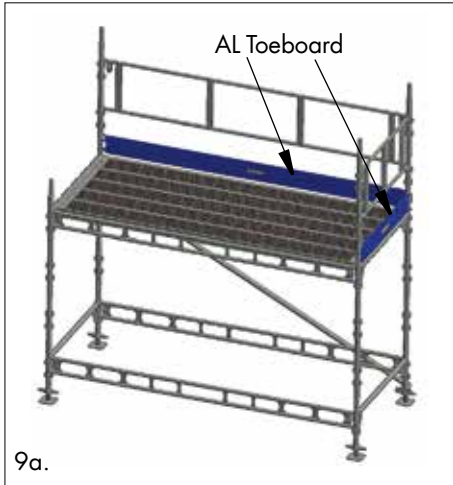
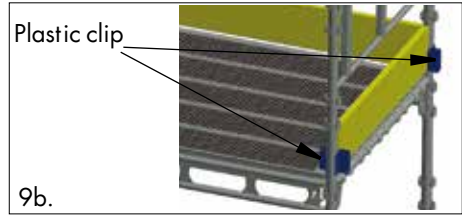
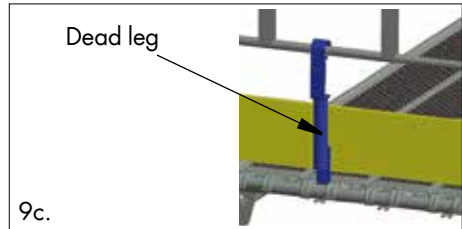
Toeboards

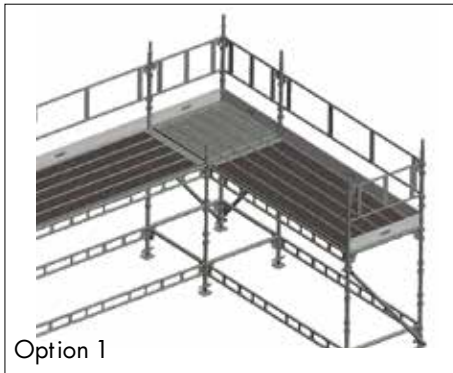
9a. AL Toeboards.

9b. Scaffold boards using plastic clip.

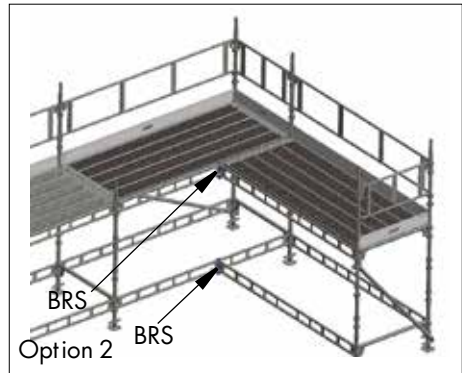
9c. Scaffold boards with HAKI Dead Leg.

Returns

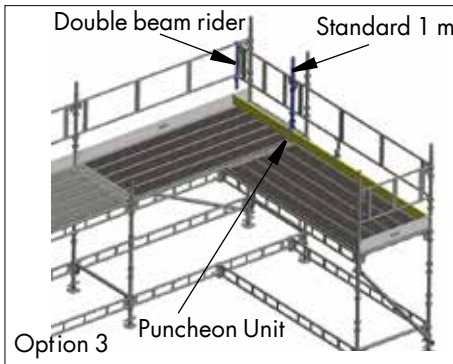
Option 1



Option 2



Option 3

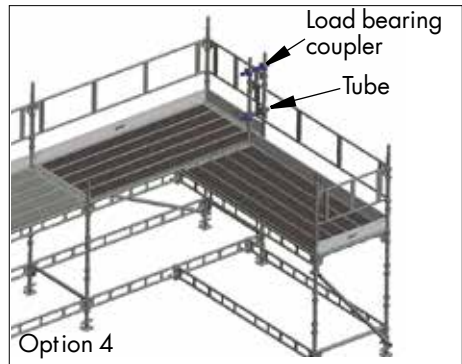

Option 4

Inside Board Brackets

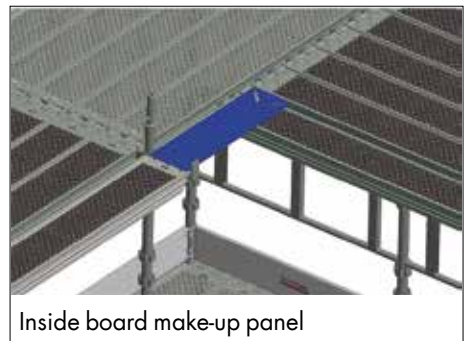
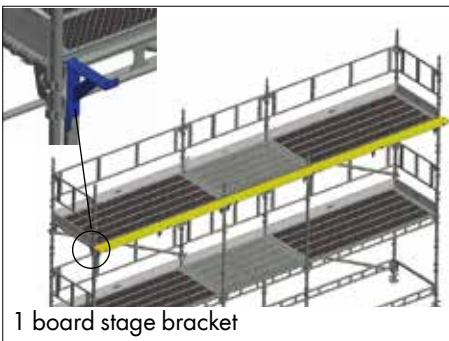
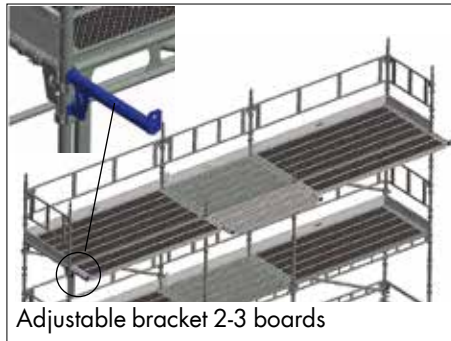
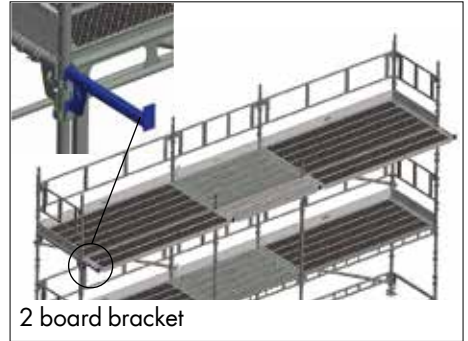
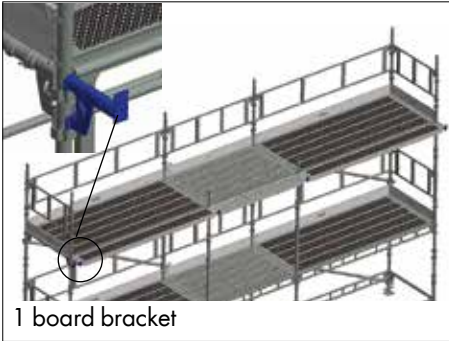

Install 1 board stage bracket over a ledger at 1200 mm centres or as required to support the scaffold board.

Inside Board make-up panel dimensions: 800mmX230mm. Install 2X12mm pins to secure the panels on the brackets.

Brackets

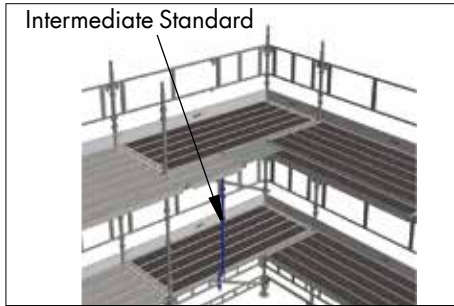

To reduce vibration on the 2-3 board brackets, an intermediate standard should be installed on a ledger. This should be positioned according to deck size.

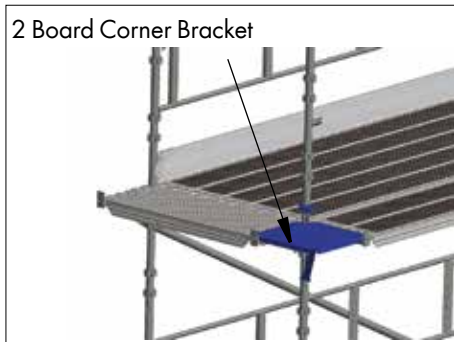

Install 2 board corner bracket on top of steel decks and fasten the wedge coupler to the standard.

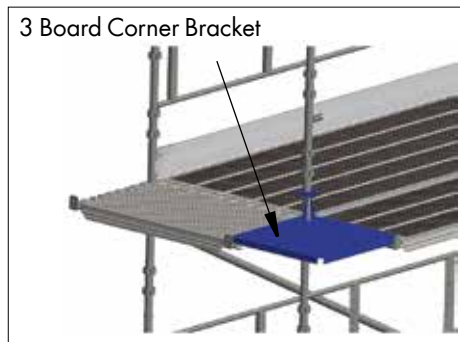

3 board corner brackets must be installed on top of a 2 board corner bracket.

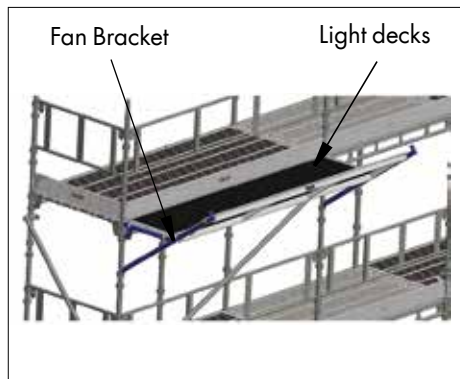
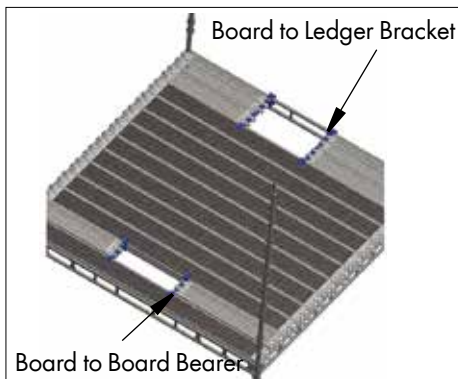

Install Light decking units on fan brackets and close locking catches.

Note: Local authority rules must be followed.



NOTE: When outside the area of collective fall protection, erectors should always be clipped to an anchor point during erection. Anchor points for personal fall protection on page 27 in this manual.

Brackets with spigot

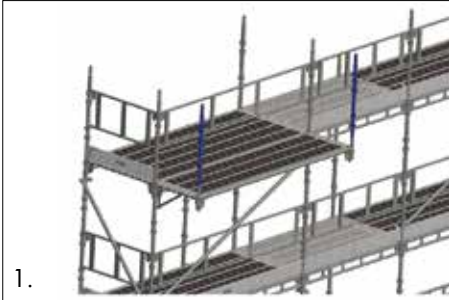

1. From behind the guardrail, install brackets with spigot and close the locking catches. Install a single ledger between the brackets. Install steel decks and 1 m standard on brackets.



2. Move guardrail forward and install all toeboards and guardrails.

5 board cantilever bracket

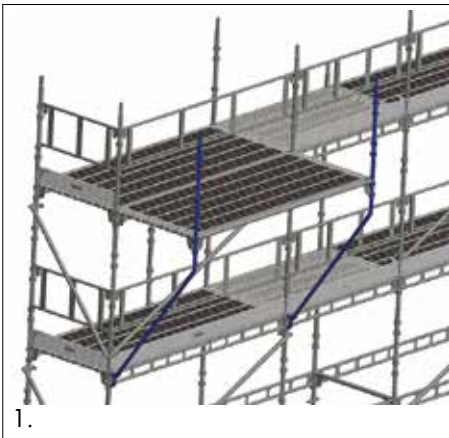

1. From behind the guardrail, install 5 board cantilever brackets and close the locking catches. Install a longitudinal single ledger between the brackets. Install transoms between the brackets and standard. Install steel decks and 1 m standard on brackets.

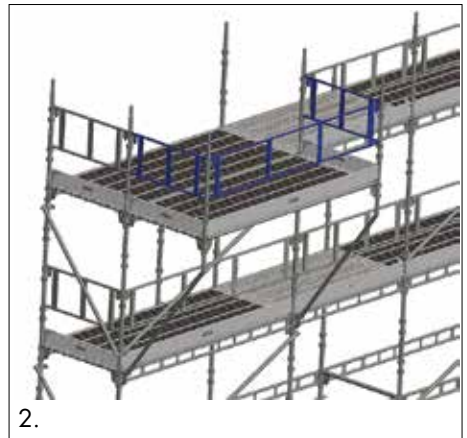

2. Move guardrail forward and install all toeboards and guardrails.

Puncheon Units

Puncheon Units application is to make “off-node” vertical connections. Puncheon units can be installed anywhere on the ledger beams, single ledgers or lattice beams.



NOTE: For Platform Loadings when using Puncheon units check Beam Loadings. (See pages 30-31 or refer to HAKI Technical Department).

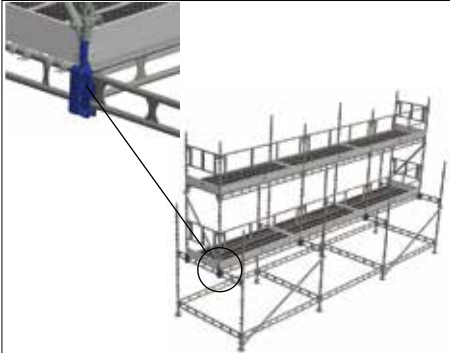

Puncheon Unit for Ledger Beams

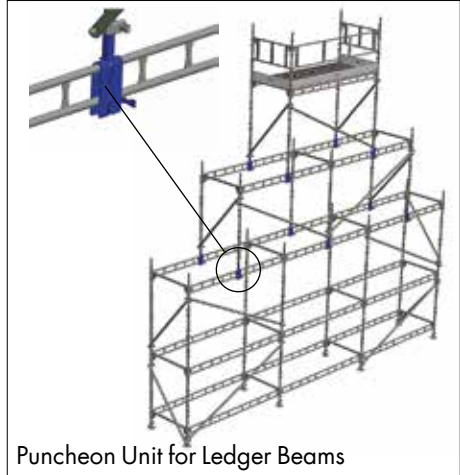

Puncheon Unit for Ledger Beams

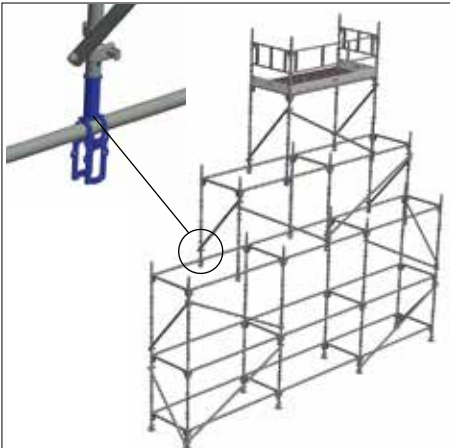

Puncheon Unit 50 for Single Ledgers



Puncheon Unit 50 for 450/750 Lattice Beams



NOTE: Diagonal braces must be installed at adjacent bays if a HAKI bridging method is used.

For bridging methods always check the permissible loads of ledgers/lattice beams. Permissible Loads on pages 30-31 in this manual or contact HAKI's technical department for more information.

Ledgers

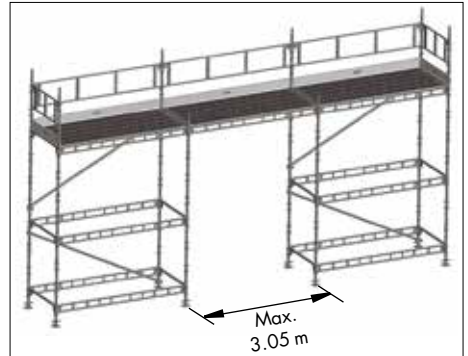
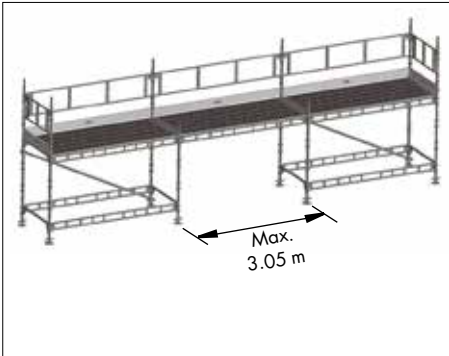

Lattice beam 500/6100: 2 bays of 3.05m

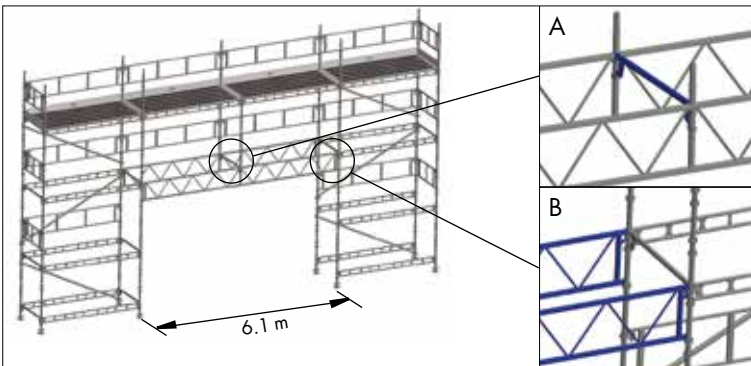

Lattice beams 500/6100 are designed to allow the scaffold to continue to be erected across a span equivalent to two 3050 mm bays.

- A. Install the Lattice Beams at the required height and close the locking catches.
- B. Install a transom between lattice beams

450/750 Aluminium Lattice Beams



NOTE: Diagonal braces must be installed at adjacent bays if a HAKI bridging method is used.

For bridging methods always check the permissible loads of ledgers/lattice beams. Permissible Loads on page 30-31 in this manual. Contact HAKI's technical department for 450/750 beams connection details and for permissible loads of beams that are not included in this manual.

Aluminium 450/750 lattice beams are installed in pairs on the inside and outside of the scaffold. Both the top and bottom chords must be fixed to the standards using SW 48x48 double couplers or 450/750 lattice beam adaptors. Top chord position should be at the same level than the decked lift.

The 450/750 lattice beams must be braced at top and chord tubes and must have section and plan braces to prevent lateral buckling and twisting.

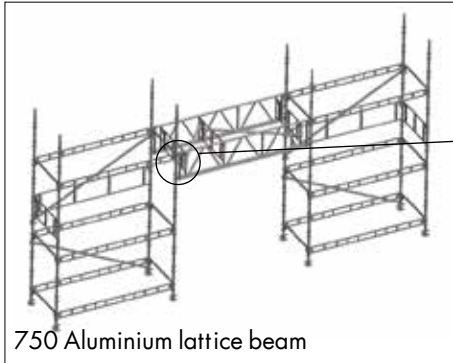

750 Aluminium lattice beam

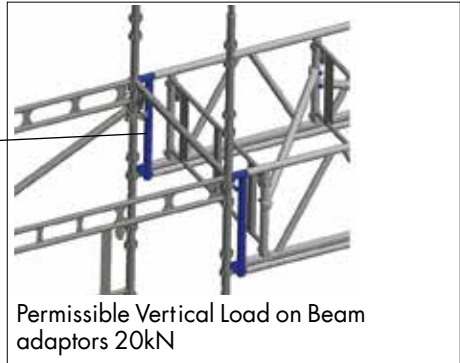

Permissible Vertical Load on Beam adaptors 20kN

HAKI Canopy

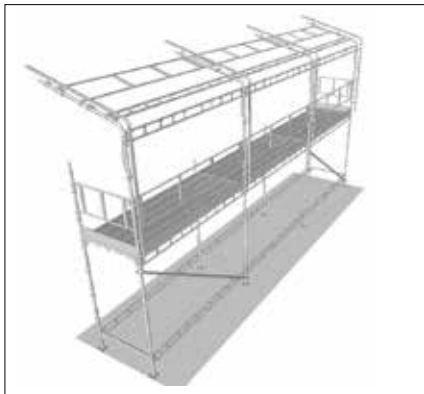

Install the canopy support section on top exterior standard. Complete the canopy with 1 m standard, guardrails and ledgers. Install HAKI tracks for HAKI sheeting.

In accordance with the Work at Height regulations, access to and egress from scaffolding should follow the hierarchy below:

1. External staircases
2. External ladder access bays with single lift ladders
3. External ladder access bays with multiple lift ladders
4. Internal ladders with protection
5. External ladder using safety gate

External staircase

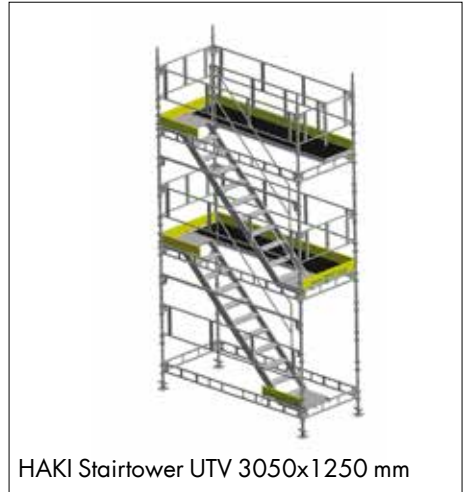
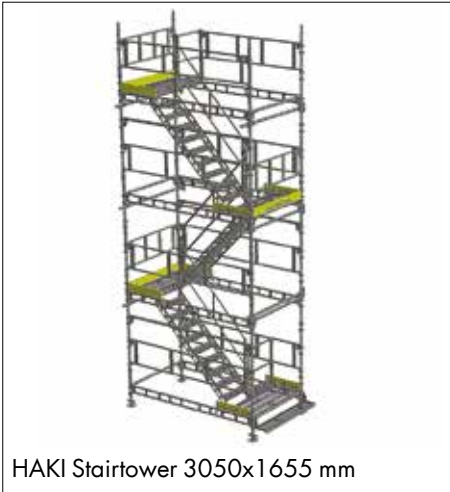

See HAKI Stairtower manual for erection procedure.

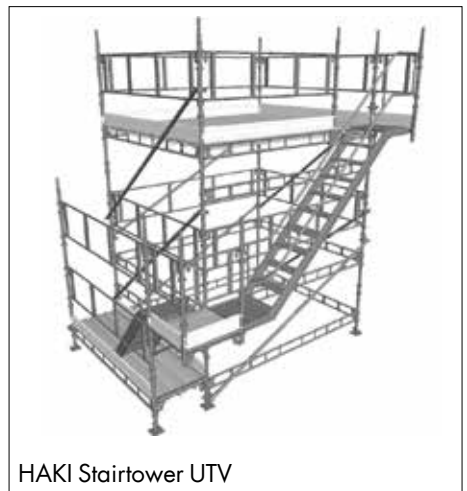

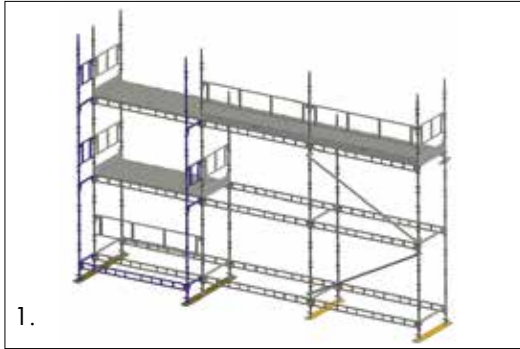
External staircase

1. The UTV staircase is installed in an external 700mm x 3050mm bay. Set out the base jacks and install the standards. Install 700 transom and 3050 beams into the lowest set of pockets. Install a second set of transoms on the second lift at 2m height. At subsequent lifts, the UTV handrails replace the ledger beams.

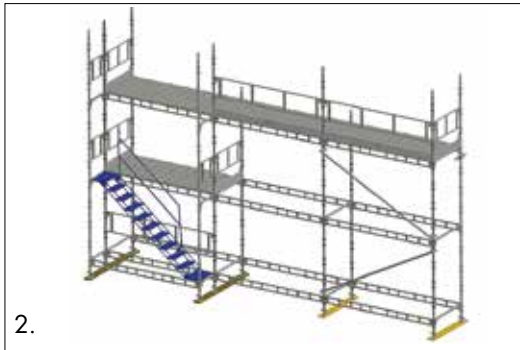

2. Install the hooks of the UTV flight over the transoms. Prevent uplift by closing locking catch. Install the UTV handrail 1m above of the flight landings. Install the internal UTV handrail. Install respective 700 guardrail frame and 700 toeboard.

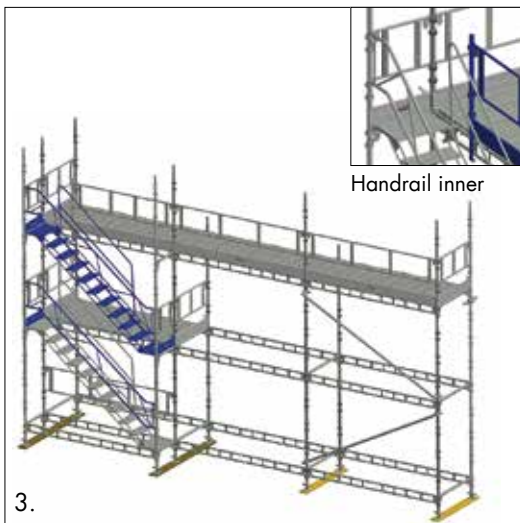

3. Continue erection up to the desired height as set out above. At top exit Install a clip-on post on the 3050 ledger beam and respective 2500 guardrail frame and toeboard.

External ladder access

To construct an external ladder access bay, build an additional bay of HAKI scaffolding.

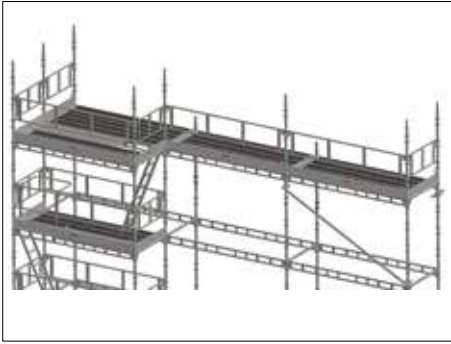

Single lift ladders: Build an additional HAKI bay.

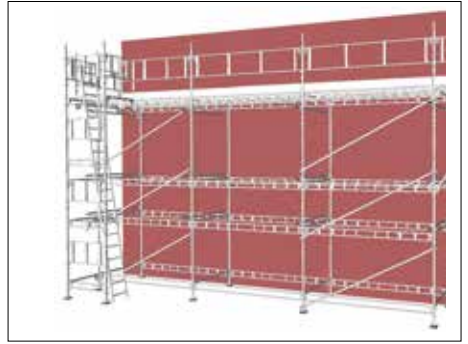

Multiple lift ladders: Provide respective Safety Gate on top lift.

Internal ladder access with steel planks



1. Remove 2x3050 steel decks and install a board to ledger bracket between the ledger beam and steel deck.



2. Install 2x1964 steel decks over the transom and board to ledger bracket. Install the ladder over the transom.



3. Install 2 double beam riders onto the Guard frame.

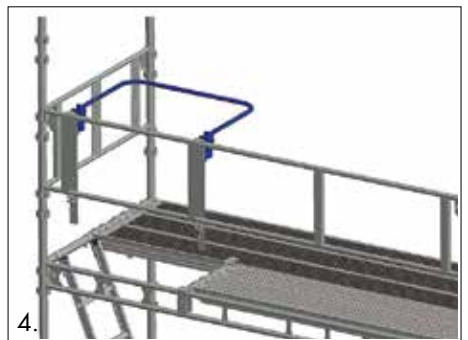

4. Install self-closing Universal Safety Gate onto Guard Frame. Install respective Toeboards.

Internal ladder access with decking units

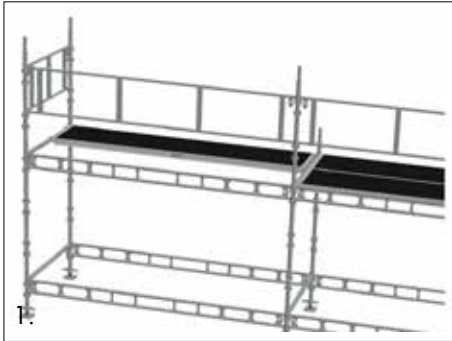

1. Install 1x600 Light decking unit.

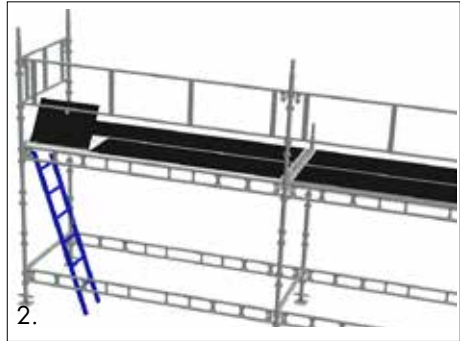

2. Install a light decking with hatch. Install the ladder over the transom. Install respective Toeboards.

Internal ladder access with scaffold boards



1. Install intermediate transom to support board. More information on page 15 in this manual.

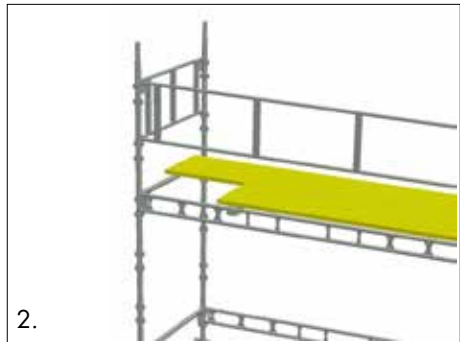

2. Install boards to suit the ladder access.

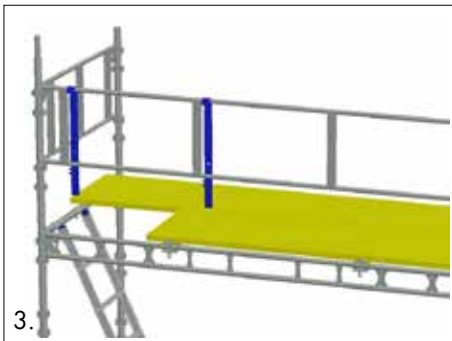

3. Install the ladder over the transom. Install 2 double beam riders onto the Guard frame.

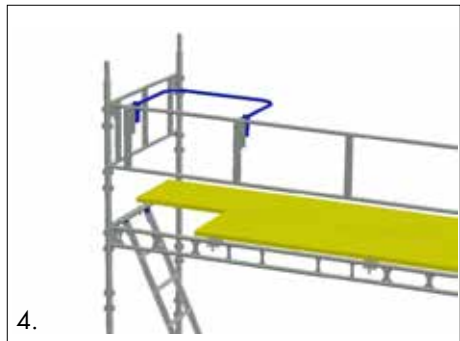

4. Install self-closing Universal Safety Gate onto Guard Frame. Install respective Toeboards.

Planning to use Advance Guard Rail



In order to be able to fit guardrails prior to decking, using HAKI's Advance Guardrail Tool or with the aid of other guardrail fitting devices, the external standards must be one metre higher than the next lift. Some alternative methods of erection to achieve this are shown here. These methods of erection also facilitate the use of temporary guardrails.

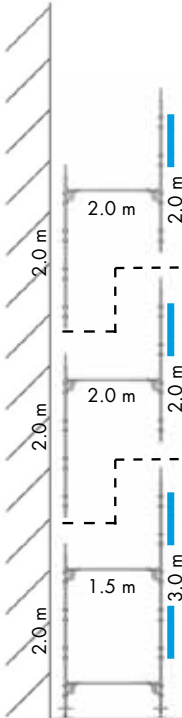

With a first lift height of 1.5 m, start with a 2.0 m standard internally and a 3.0 m standard externally. Continue with lift heights of 2.0 m, using 2.0 m standards both internally and externally.

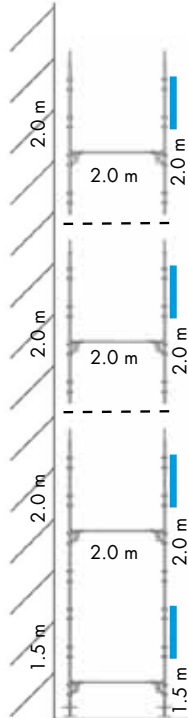

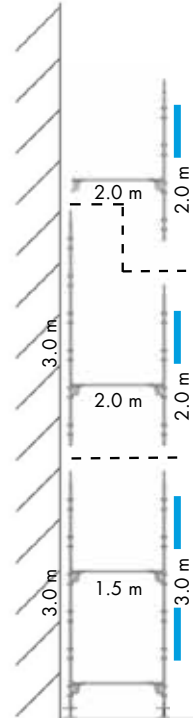

With lift heights of 2.0 m, start with a 1.5 m standard both internally and externally. Continue with 2.0 m standards both internally and externally.



With a first lift height of 1.5 m, start with 3.0 m standards both internally and externally. Continue with lift heights of 2.0 m, using 3.0 m standards internally and 2.0 m standards externally.

Anchorage Points for Personal Fall Protection Equipment

NOTE: Recommendations for 100% Clip-On solutions for HAKI Universal apply if:

-  Only one person is attached to the component.
-  No other loads are applied to the component.
-  Approved Fall Protection Equipment is used i.e. **Shock Absorbing** Lanyards meeting the requirements of BS EN 355.

The **only permissible** anchor points that provide fall arrest are described below, NO other points of attachment are recommended.

- A. Bottom chord of Ledger Beams fixed in a bay of up to and including 3.05m.
- B. Single Ledger Beams (ERB) fixed in a bay of up to and including 3.05m.
- C. "Hook" locked to a BRS which is already fixed on a Ledger Beam, in a bay of up to and including 3.05m.
- D. "Hook" locked in position on unrestrained standards connected up to 1m. NOT next to a standard joint, unless the joint is pinned.
- E. "Hook" locked to standards in a complete 2m lift up to 1.5m.

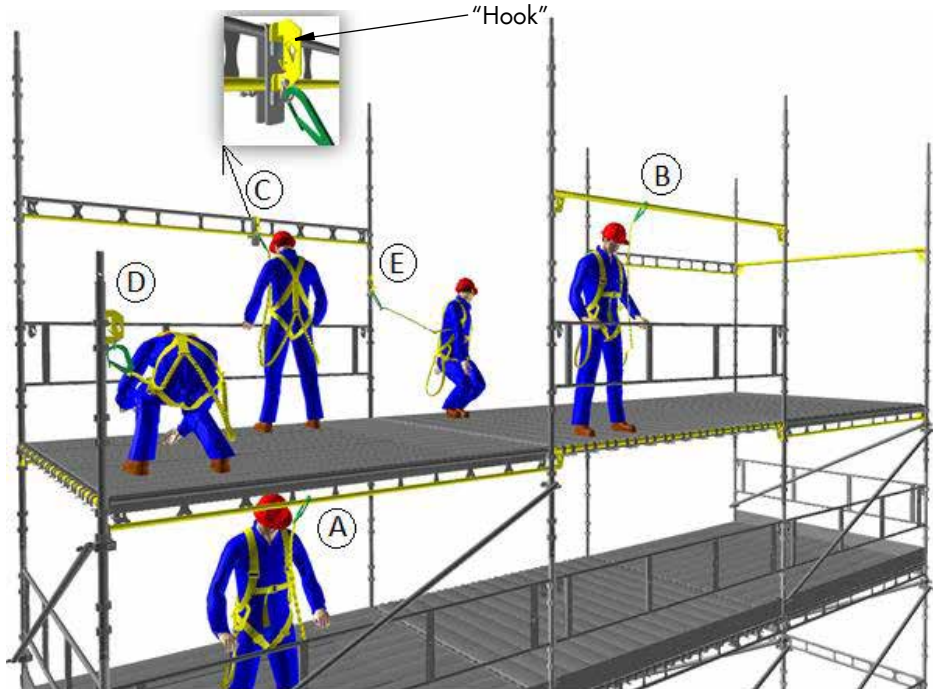

Components that have been subjected to loading from a fall must be replaced by new material.

Fall protection equipment MUST NOT be attached to Guardrail Frames, Brackets, or Cantilevers.

Fall protection equipment MUST NOT be attached to components that have not been locked into place.

Base jacks

The scaffolding is mounted on base jacks which are adjustable in height between 55 and 570mm.

If more adjustments are needed, screw the base jacks down and assemble the beams to the next group of pockets. This means that the Standards can always be adjusted to ensure that the beams are horizontal.

Standards

Standards of length 3000mm or 2000mm are normally used in the scaffold.

However 1500mm Standards may be used at the bottom of the scaffold in accordance with the alternative method of erection described on page 27.

Horizontals

Generally, the scaffold is erected using Ledgers and/or Ledger beams as ledgers and transoms with a height of 2000mm between the lifts. Each lift must be fitted horizontals on both the inside and the outside faces. The lower-most lift should always be installed at the lowest possible pocket level.

Guardrails

Decked lifts must be provided with guard-rail frames or double guardrails and toeboards.

The guardrail height must be a minimum of 950mm above decking level.

Decking

Load classes

Decking	Width [mm]	Length [mm]	Load class
Decking units	400, 600	1250-3050	3
Steel Decks	230	770-2250 3050	6 5
Aluminium planks	230	770-2250 3050	6 5

HAKI Steel Decks: Typical configuration		
No. of Decks and Insert Panels		
Bay size[mm]	No. of Steel Decks	No. of Insert Panels
3050	13	0
2500	10	1
1964	8	0
1655	7	0
1250	5	0
1010	4	0





➔ +2 BRS and 1 Single Ledger

➔ +2 BRS and 1 Single Ledger if Ledger Beams are used at the ends. Not necessary if single ledger are used at ends.

Permissible loads on Horizontals

Permissible loads erected on HAKI standards.

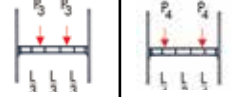
Type of beam					
	Permissible load q [kN/m]	Uniformly distributed load Q [kN]	Centre point load P [kN]	Permissible point loads	
				P ₃ [kN]	P ₄ [kN]
LBL 1050	32.4	34.0	11.0	11.0	12.4
LBL 1250	21.4	26.7	9.5	8.5	10.0
LBL 1655	15.1	25.0	9.2	7.7	10.1
LBL 1964	11.3	22.2	6.9	6.7	10.0
LBL 2500	7.9	19.8	7.0	7.1	8.0
LBL 3050	5.2	15.7	5.8	5.7	7.2
LB 3650	2.4	8.6	4.3	3.2	4.3
LB 4050	2.4	9.6	4.8	3.6	4.8
ERB 700	39.3	26.0	13.0	9.8	13.0
ERB 770	38.5	26.0	13.0	9.8	13.0
ERB 1010					
ERB 1050	25.4	26.0	13.0	9.8	13.0
ERB 1250	21.7	26.0	13.0	9.8	13.0
ERB 1655	12.4	19.9	10.0	7.5	10.0
ERB 1964	7.7	14.8	7.7	5.8	7.7
ERB 2050	7.1	14.2	7.4	5.5	7.4
ERB 2500	3.8	9.3	4.7	3.5	4.7
ERB 3050	3.0	9.0	4.5	3.4	4.5

Brackets

Load classes for brackets apply provided that the brackets are fitted in a bay of length max. 3050 mm.

In the specified load classes, no consideration has been paid to the bearing capacity of the decking. The permissible load class can never be greater than the load class for the decking.

Bracket	Load class
SK 230	6
SK 400	5
SK 460	4
SK 600	3
SK 514 with spigot	3
SK 720 with spigot	3
SK 460-690	3
SKD 1200	3



Load classes

Refers to EN 12811-1.

Loadclass	Uniformly distributed load [kN/m ²]	Concentrated load on area 0.5m x 0.5m [kN]	Load of one person on area 0.2m x 0.2m [kN]	Partial area load	
				Load [kN/m ²]	Partial [m ²]
1	0.75	1.5	1.0	-	-
2	1.5	1.5	1.0	-	-
3	2.0	1.5	1.0	-	-
4	3.0	3.0	1.0	5.0	0.4 A
5	4.5	3.0	1.0	7.5	0.4 A
6	6.0	3.0	1.0	10.0	0.5 A

A=the area between two pairs of standards

Permissible loads on lattice beams

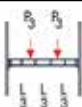
				
Lattice beam	Permissible load q [kN/m]	Uniformly distributed load Q [kN]	Centre point load P [kN]	Point loads P ₃ [kN]
Steel 500/6100	2.93	17.7	12.3	-
450 Aluminium FB 4100 AL FB 6100 AL FB 8100 AL	4.9 3.0 1.7	19.4 18.3 13.7	7.5 7.5 6.9	7.5 6.9 5.1



NOTE: Contact the HAKI's technical department for permissible loads on 750 Lattice Beams.

Bracing and tying-in

Vertical diagonal bracing between the outside standards must be installed in every 5th bay and always in the end bays. Guard rail frames can replace vertical diagonal braces, but **MUST** be fitted in each bay and at every lift level, including the bottom level.

Each inside standard must be tied to the facade or equivalent at every 4th metre in height adjacent to the node between standard and beam.

The lowest tie must be fitted no more than 4.8 m above ground level.

There must be ties that can carry horizontal forces on at least every 6th pair of standards along the scaffold and at every level of ties. In addition, we recommend that the scaffold always be anchored as high up as possible.

Ties that can withstand horizontal forces should be dimensioned for a load of 5.5 kN parallel with the façade and 6.5 kN perpendicular to the façade. Other ties should be dimensioned for a load of 4.6 kN perpendicular to the façade.

Where a scaffold is covered in sheeting, the number of ties must be increased to take account of wind load. Separate calculations are therefore required.

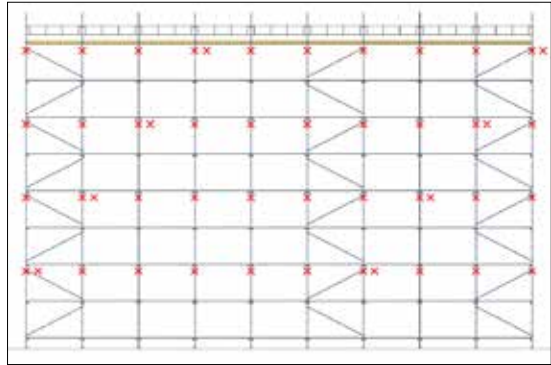

Bracing with vertical diagonal braces and tying-in

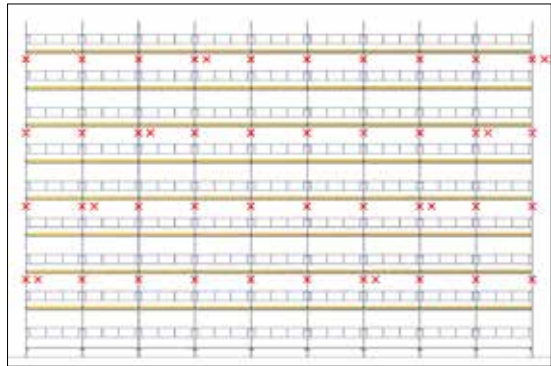

Bracing with GFL/GFLH guardrail frames and tying-in

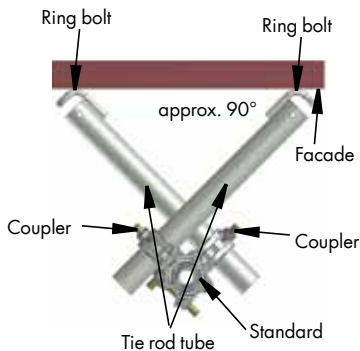

Examples of ties that can carry horizontal forces.

Topping up

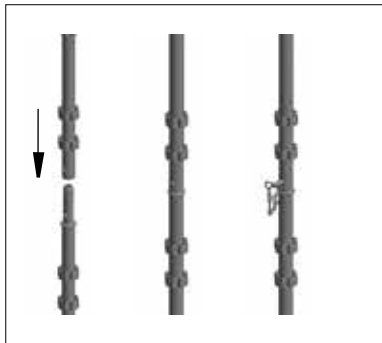

The standards **must** be pinned if the scaffold is crane lifted, suspended, used to support a temporary roof or clad i.e. sheeting/debris-netting.

Maximum tension load on pinned standards: 20kN.

Scaffold with inside Boards

All joints above uppermost tie **must** be pinned.



SAFETY CHECKLIST

1. Decking checked with regard to load-bearing capacity
2. Distance to wall or similar as small as possible
3. Scaffold aligned correctly horizontally and vertically
4. Components correctly fitted and locked
5. Bracing correctly fitted
6. Anchoring with correct number and placement of tested ties
7. Decking correctly fitted
8. Guardrail with toeboard
9. Suitable means of access to and egress from scaffold
10. Scaffold erected for correct class of load

Maintenance & storage

1. After use, all components must be thoroughly cleaned and inspected before storage.
2. Any damaged parts or components found must be replaced.
3. The manufacturer or supplier must be consulted before repairing scaffold material.
4. Components must be sorted and stacked properly. Take care not to pile the stacks too high, so that the material lower down in the stacks becomes overloaded and damaged. If the material must be stacked up high, suitable racking and shelves should be used.
5. Wooden and plastic components (e.g. platforms, toe boards, toe board holders, etc.) should be stored in a sheltered area so as to maximize their working life.

Wind, ice and snow

During the winter months, when extreme weather conditions can occur, it is important to remove snow and ice immediately.

With regards to wind loads, ties must be installed every fourth metre in height; see the section "Bracing and tying-in". For clad scaffolding, calculations should be made in each individual case.

For more information, please contact HAKI's technical department.

HAKI® Experience

With over 50 years experience to call on, HAKI has gained a leading reputation in its field. With its own R & D and manufacturing facilities, the company now operates throughout Europe and its equipment is in use worldwide. With all products designed and manufactured to ISO 9001:2008, and a comprehensive training and support infrastructure, you can rely on HAKI for support.

HAKI® Training

The Company's dedicated Training Centre is equipped with the full range of HAKI products where a comprehensive choice of courses is offered. With the benefit of this training, all users of HAKI products can be assured that the equipment is being employed safely and effectively.

HAKI® Support

From computerised estimating facilities to on site assessment and project back up, HAKI is with its customers every step of the way. Working with HAKI means far more than just proven equipment, it means working with People who understand the scaffolding industry. Whatever the project, the company is committed to ensuring every user enjoys the full benefits associated with the use of HAKI - maximising the savings, profitably, and above all, SAFETY.

Health and Safety at Work Act, 1974

HAKI equipment is designed to meet the requirements of the above Act, Section 6.

It is also the customer's responsibility to comply with the requirements of this Act, particularly to use the equipment in accordance with current codes of practice and in ensuring that components are in good working condition prior to each use.

We are able to provide assistance and advice on matters relating to safe and proper use of HAKI equipment.

